

REVISION	DRN BY	DRN DATE	CHK BY	CHK DATE	CHANGE DESCRIPTION
01	JMc	11/07/24	TE	11/07/24	Initial drawing
-	-	-	-	-	-
-	-	-	-	-	-

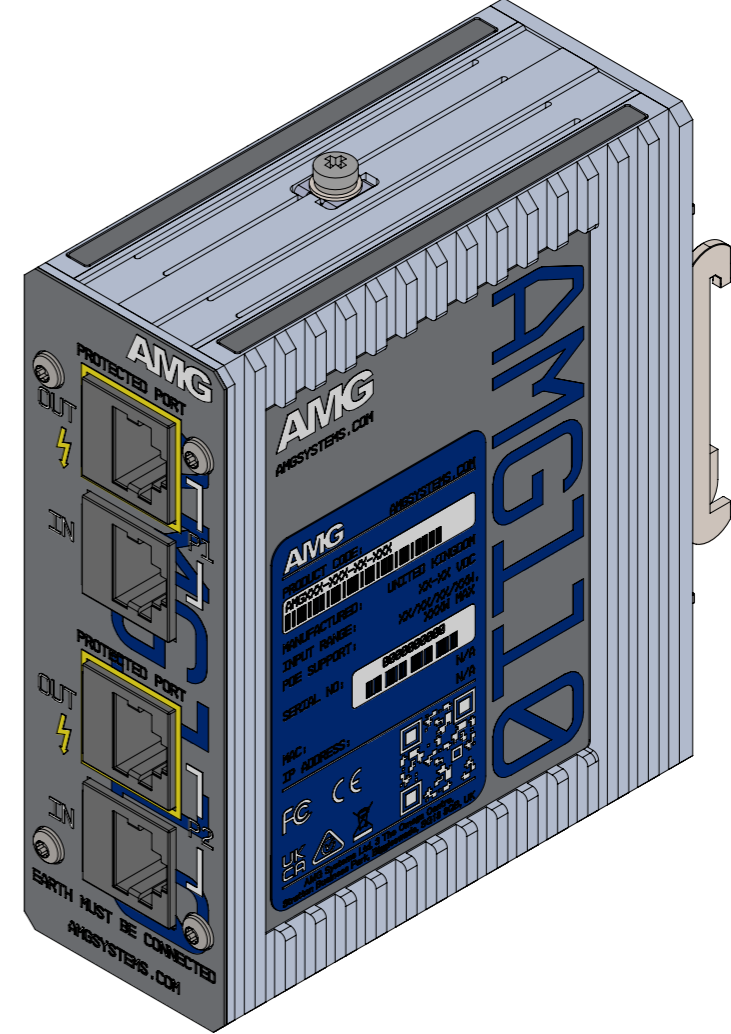

DWG NO. <b>AMG110-2X-SP</b>		REVISION <b>01</b>	
DEBURR AND BREAK SHARP EDGES DO NOT SCALE DRAWING		TITLE: <b>AMG110-2X-SP Dimensional drawing</b>	
UNLESS OTHERWISE SPECIFIED: DIMENSIONS ARE IN MILLIMETERS TOLERANCES: LINEAR: +/- 0.1 ANGULAR: +/- 0.5		FINISH: MATERIAL:	
		Document is property of AMG Systems Ltd and must not be shared, copied or printed without prior consent. SCALE:1:1 SHEET 1 OF 2	

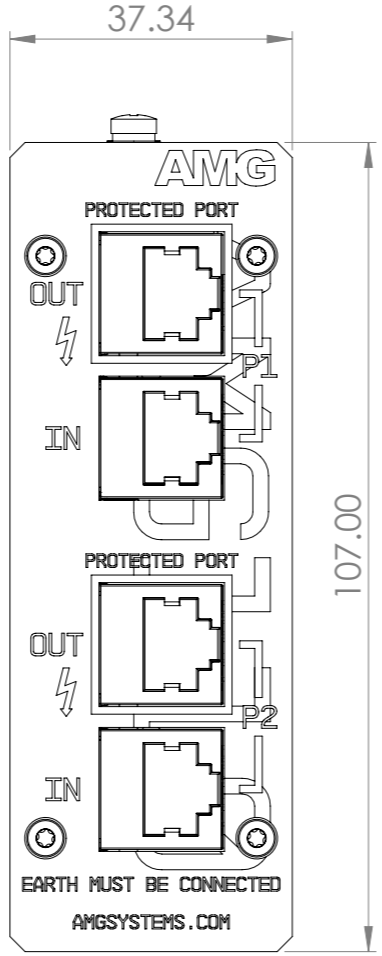
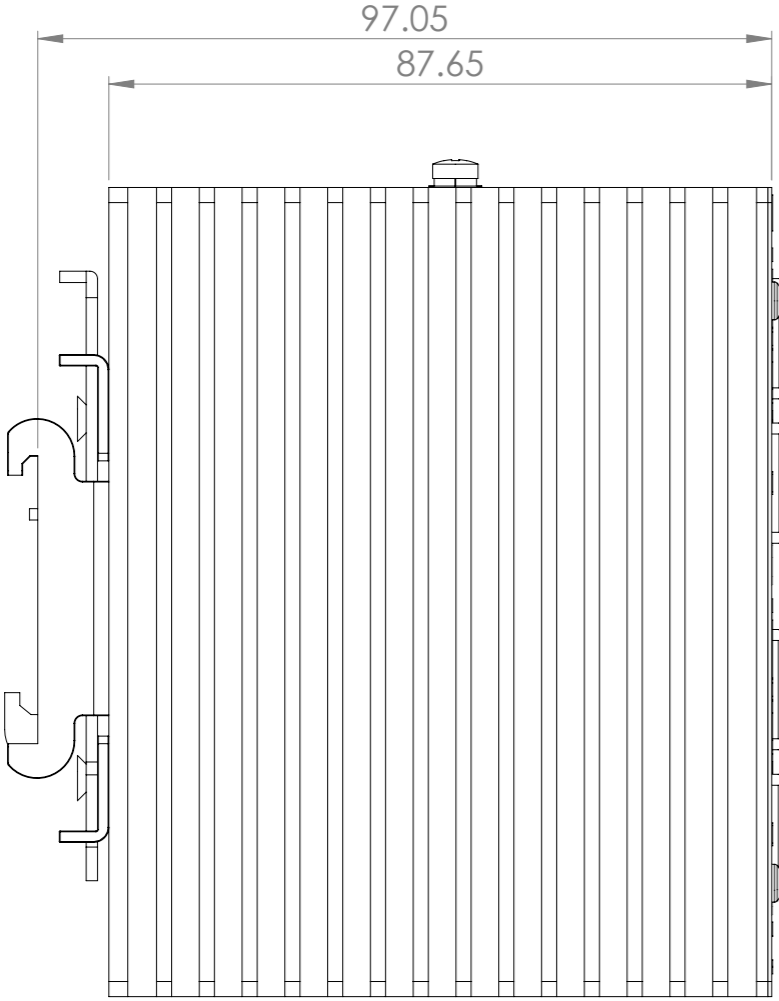
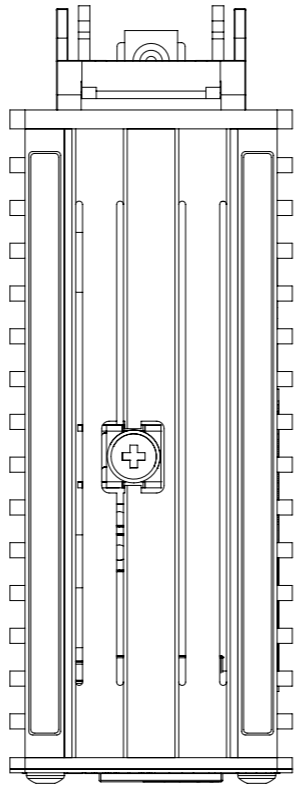
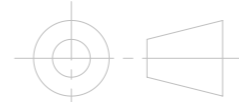

REVISION	DRN BY	DRN DATE	CHK BY	CHK DATE	CHANGE DESCRIPTION
01	JMc	11/07/24	TE	11/07/24	Initial drawing
-	-	-	-	-	-
-	-	-	-	-	-

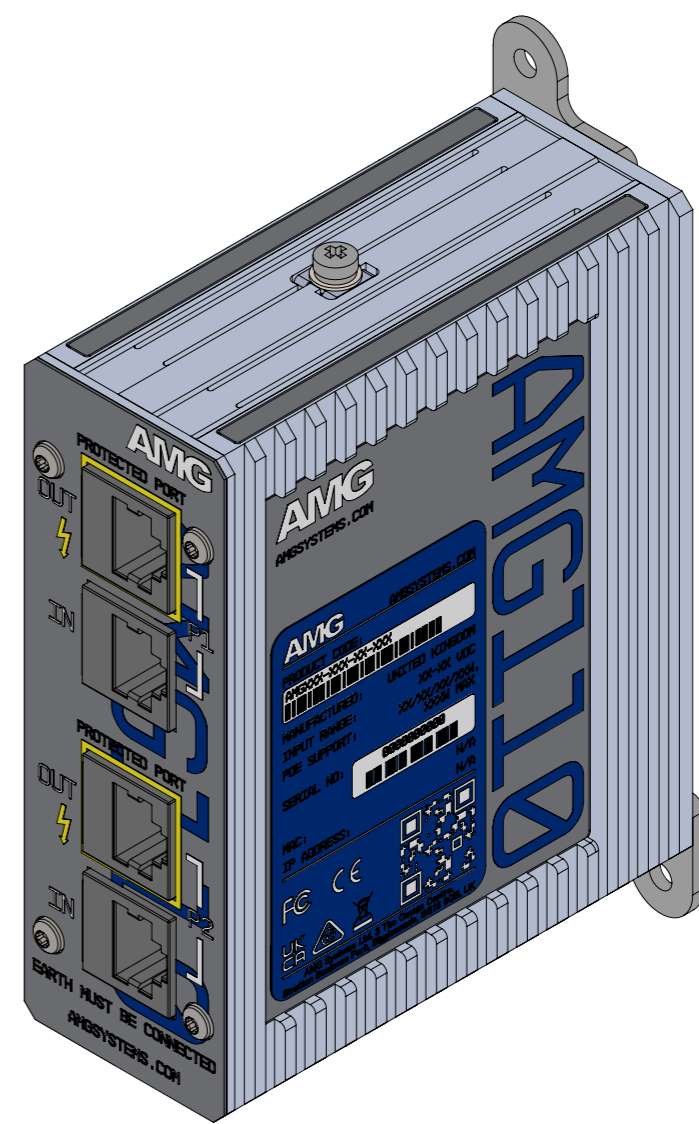
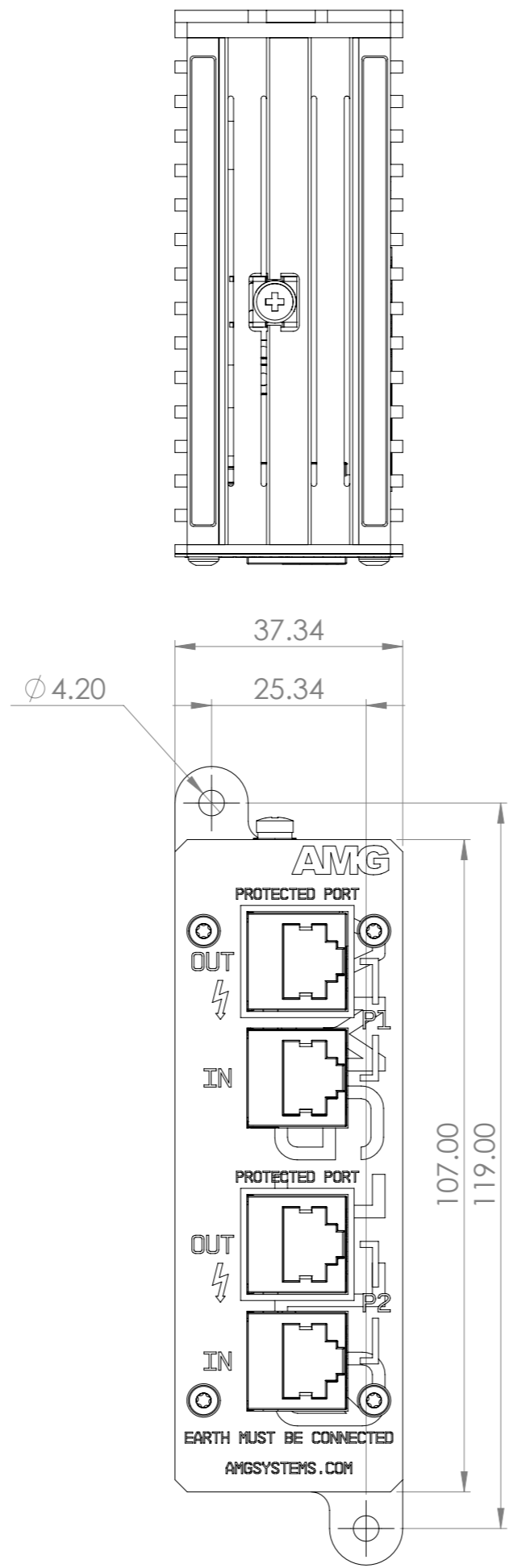
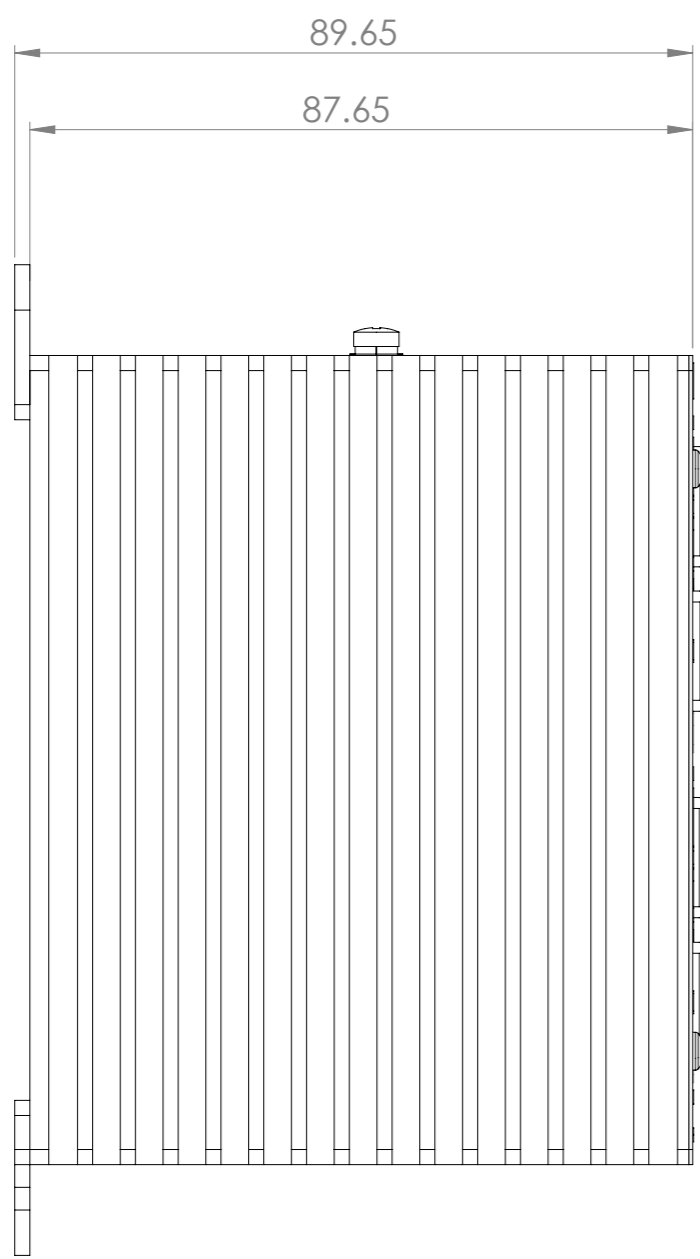

DEBURR AND BREAK SHARP EDGES  
DO NOT SCALE DRAWING

UNLESS OTHERWISE SPECIFIED:  
DIMENSIONS ARE IN MILLIMETERS  
TOLERANCES:  
LINEAR: +/- 0.1  
ANGULAR: +/- 0.5



DWG NO. <b>AMG110-2X-SP</b>	TITLE: <b>AMG110-2X-SP Dimensional drawing</b>	REVISION 01
FINISH:	MATERIAL:	A3
Document is property of AMG Systems Ltd and must not be shared, copied or printed without prior consent.		SHEET 2 OF 2

SCALE:1:1